

Features

- Low reverse current and low forward voltage
- High reliability
- Small surface mounting type

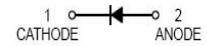

Typical Applications

- For general purpose applications



Mechanical Data

- Case: SOD-123
- Molding compound, UL flammability classification rating 94V-0
- Terminals: Tin plated leads, solderable per MIL-STD-202, Method 208

SOD-123

Ordering Information

| Part Number | Package | Shipping | Marking Code |
|-------------|---------|----------------|--------------|
| SD103AW | SOD-123 | 3000/Tape Reel | S4 |
| SD103BW | SOD-123 | 3000/Tape Reel | S5 |
| SD103CW | SOD-123 | 3000/Tape Reel | S6 |

Maximum Ratings (@T_A=25°C unless otherwise specified)

| Characteristic | Symbol | SD103AW | SD103BW | SD103CW | Units |
|---|--------------------|---------|---------|---------|-------|
| Peak repetitive reverse voltage | V _{RRM} | 40 | 30 | 20 | V |
| RMS Reverse voltage | V _{RMS} | 28 | 21 | 14 | V |
| Maximum average forward output current | I _{F(AV)} | 350 | | | mA |
| Peak forward surge current, 8.3ms single half-sine-wave | I _{FSM} | 2 | | | A |

Thermal Characteristics

| Characteristic | Symbol | Value | Units |
|--------------------------------------|--------------------|-------------|-------|
| Power dissipation | P _D | 400 | mW |
| Thermal Resistance Junction-to-Air | R _{θJA} * | 250 | °C/W |
| Thermal Resistance Junction-to-Case | R _{θJC} * | 138 | °C/W |
| Operating junction temperature range | T _J | 125 | °C |
| Storage temperature range | T _{STG} | -55 to +150 | °C |

Part mounted on FR-4 board with recommended pad layout

Electrical Characteristics (@ $T_A=25^{\circ}\text{C}$ unless otherwise specified)

| Characteristic | Symbol | Test conditions | Min. | Typ. | Max. | Units |
|-------------------------------|------------|--|------|------|------|---------------|
| Forward Voltage | V_F^* | $I_F=20\text{mA}$ | - | - | 0.37 | V |
| | | $I_F=200\text{mA}$ | - | - | 0.60 | |
| Maximum Peak Reverse Current | I_R^{**} | $V_R=30\text{V}$ (SD103AW) $V_R=20\text{V}$ (SD103BW) $V_R=10\text{V}$ (SD103CW) | - | - | 5 | μA |
| Capacitance between terminals | C_T | $V_R=0\text{V}, f=1\text{MHz}$ | - | 22 | 50 | pF |
| Reverse Recovery Time | t_{rr} | $I_F=I_R=200\text{mA}$, $I_{rr}=0.1 \times I_R, R_L=100\Omega$ | - | 10 | - | ns |

Pulse width $\leq 380 \mu\text{s}$, Duty cycle $< 2\%$
 pulse test, $t_p \leq 5\text{ms}$

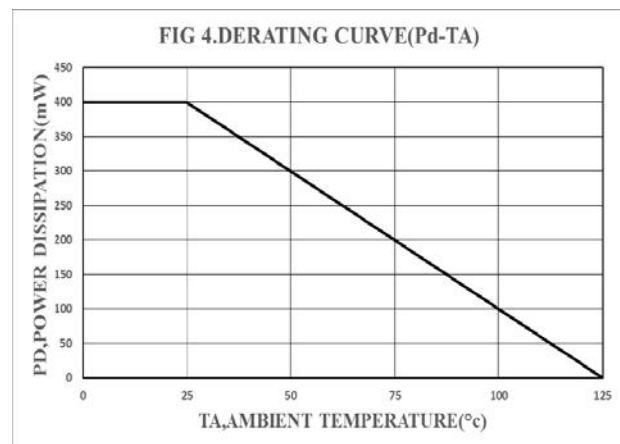
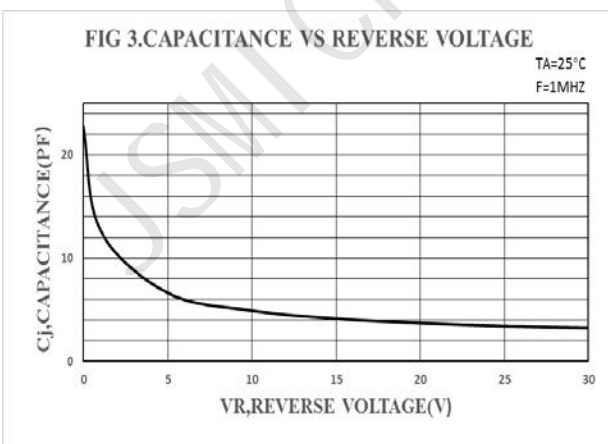
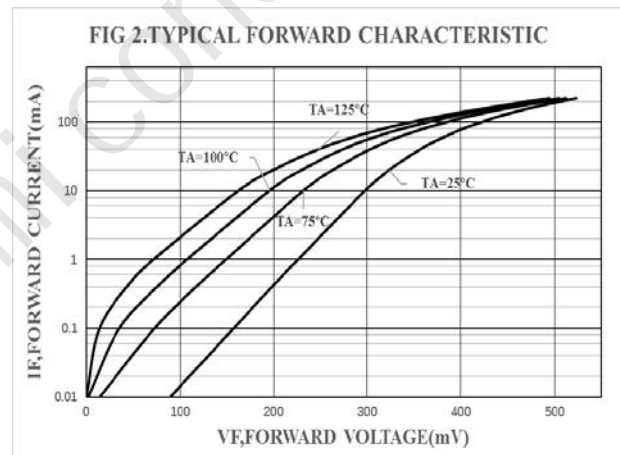
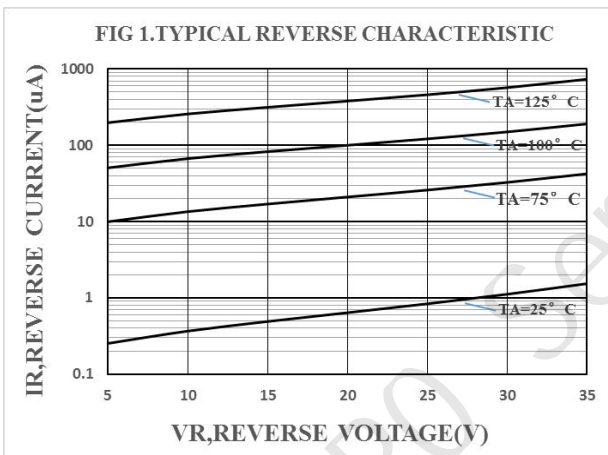
Ratings and Characteristic Curves ($T_A=25^{\circ}\text{C}$ unless otherwise noted)

Package Outline Dimensions(unit:mm)

SOD-123

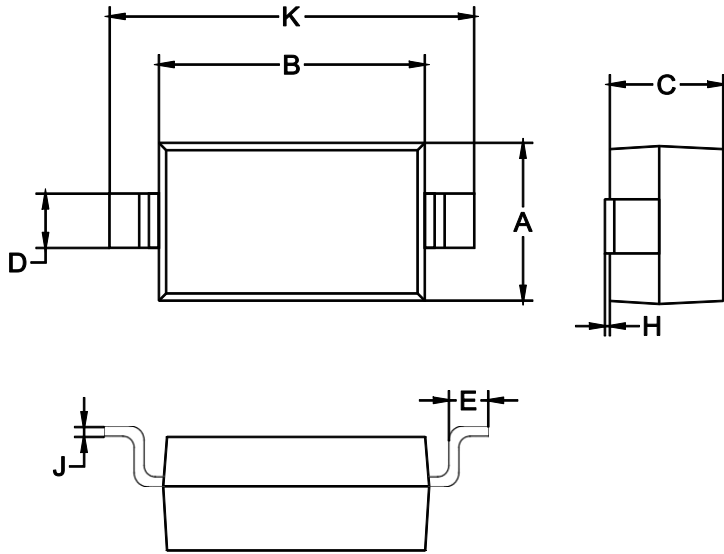

SOD-123

| Dim | Min | Max |
|-----|------|------|
| A | 1.45 | 1.75 |
| B | 2.55 | 2.85 |
| C | 1.00 | 1.30 |
| D | 0.50 | 0.60 |
| E | 0.25 | 0.45 |
| H | 0.02 | 0.10 |
| J | 0.05 | 0.15 |
| K | 3.55 | 3.85 |

Mounting Pad Layout(unit:mm)

SOD-123

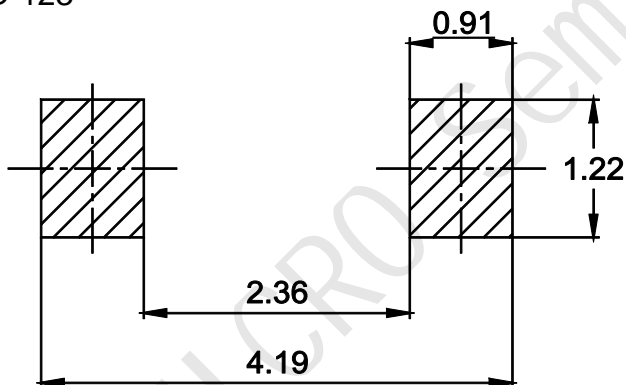
IMPORTANT NOTICE

Jsmicro Semiconductor (JSM) reserves the right to make changes without further notice to any product herein to make corrections, modifications , improvements , or other changes. JSM does not assume any liability arising out of the application or use of any product described herein; neither does it convey any