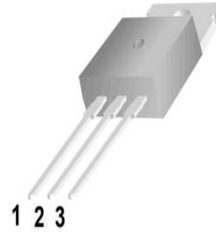
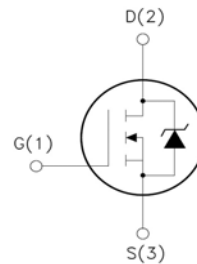
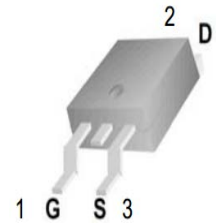

Features:

- Low Intrinsic Capacitances.
- Excellent Switching Characteristics.
- Extended Safe Operating Area.
- Unrivalled Gate Charge :Qg= 126.7nC (Typ.).
- BVDSS=100V, I_D=140A
- R_{DS(on)} : 7.2mΩ (Max) @V_G=10V
- 100% Avalanche Tested

TO-220

T0-263

- 1.Gate (G)
- 2.Drain (D)
- 3.Source (S)

Absolute Maximum Ratings (T_A=25°C unless otherwise noted)

Symbol	Parameter	Maximum	Unit
V _{DSS}	Drain-to-Source Voltage	100	V
V _{GSS}	Gate-to-Source Voltage	±25	V
I _D ³	Continuous Drain Current	T _C =25°C	140
		T _C =100°C	97
I _{DP} ⁴	Pulsed Drain Current	T _C =25°C	530
I _{AS} ⁵	Avalanche Current	33	A
EAS ⁵	Avalanche energy	560	
PD	Maximum Power Dissipation	T _C =25°C	215
		T _C =100°C	105
T _J , T _{STG}	Junction & Storage Temperature Range	-55~175	°C

Thermal Characteristics

Symbol	Parameter	Typical	Unit
Rθjc	Thermal Resistance-Junction to Case	0.68	°C/W
Rθja	Thermal Resistance-Junction to Ambient	62.5	

Electrical Characteristics (TA=25°C unless otherwise noted)

Symbol	Parameter	Test Conditions	Min.	Typ	Max.	Unit
Static Characteristics						
BV _{DSS}	Drain-Source Breakdown Voltage	V _{GS} =0V, I _D =250μA	100	—	—	V
I _{DSS}	Zero Gate Voltage Drain Current	V _{DS} =80V, V _{GS} =0V	—	—	1	μA
		T _J =125°C	—	—	20	
V _{GS(th)}	Gate Threshold Voltage	V _{DS} =V _{GS} , I _D =250μA	2	3	4	V
I _{GSS}	Gate Leakage Current	V _{GS} =±25V, V _{DS} =0V	—	—	±100	nA
R _{DS(on)} ¹	Drain-Source On-Resistance	V _{GS} =10V, I _D =60A	—	6.2	7.2	mΩ
			—	—	—	
Diode Characteristics						
V _{SD} ¹	Diode Forward Voltage	I _{SD} =60A, V _{GS} =0V	—	0.8	1.3	V
I _S ³	Diode Continuous Forward Current		—	—	50	A
t _{rr}	Reverse Recovery Time	I _F =60A, V _{DD} =50V	—	65	—	nS
Q _{rr}	Reverse Recovery Charge	di/dt=100A/μs	—	102	—	nC
Dynamic Characteristics²						
R _G	Gate Resistance	V _{GS} =0V, V _{DS} =0V, Frequency=1MHz	—	1.8	—	Ω
C _{iss}	Input Capacitance	V _{GS} =0V, V _{DS} =25V, Frequency=1MHz	—	6235	—	pF
C _{oss}	Output Capacitance		—	942	—	
C _{rss}	Reverse Transfer Capacitance		—	506	—	
t _{d(on)}	Turn-On Delay Time	V _{DD} =50V, I _D =30A, V _{GS} =10V, R _G =25Ω	—	51	—	nS
t _r	Rise Time		—	116	—	
t _{d(off)}	Turn-Off Delay Time		—	247	—	
t _f	Fall Time		—	150	—	
Gate Charge Characteristics²						
Q _g	Total Gate Charge	V _{DS} =80V, V _{GS} =10V, I _D =30A	—	126.7	—	nC
Q _{gs}	Gate-to-Source Charge		—	20	—	
Q _{gd}	Gate-to-Drain Charge		—	55.5	—	

Note: 1: Pulse test; pulse width ≤ 300μs, duty cycle ≤ 2%.

2: Guaranteed by design, not subject to production testing.

3: Package limitation current is 50A. Calculated continuous current based on maximum allowable junction temperature.

4: Repetitive rating, pulse width limited by max junction temperature.

5: Starting T_J = 25°C, L = 0.5mH, V_{DD}=90V. I_{as}=66A

Typical Characteristics

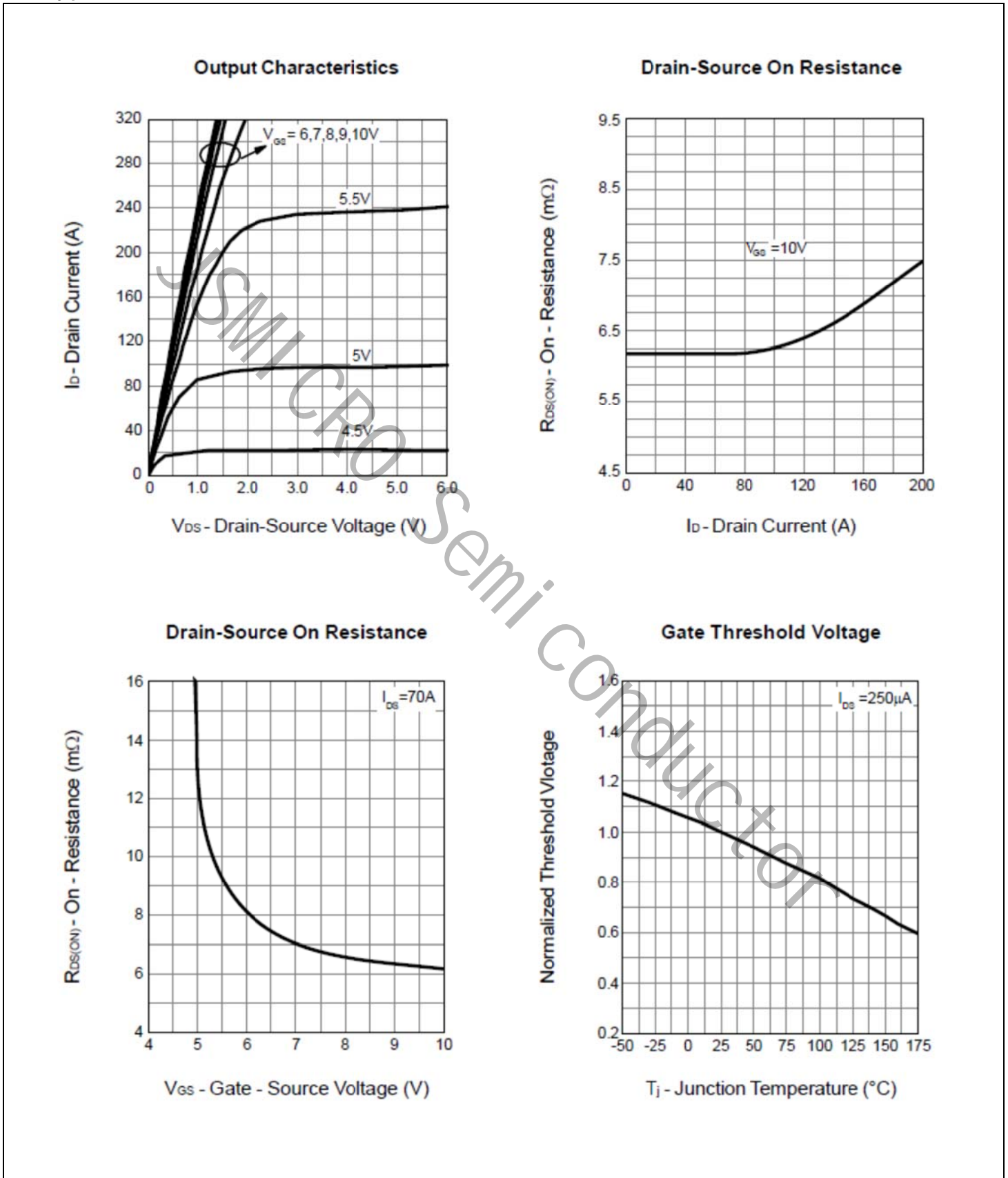

Typical Characteristics (Continued)

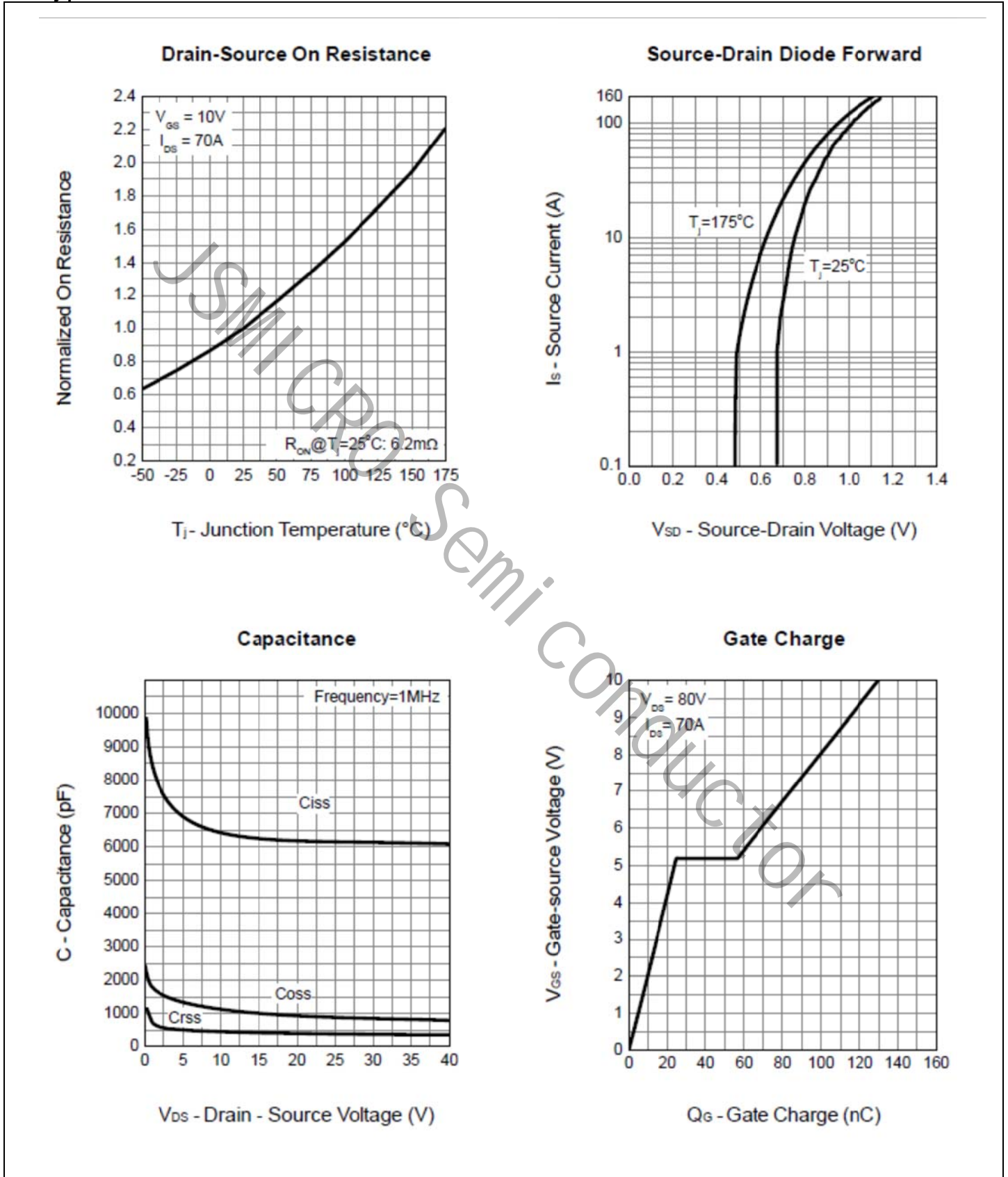

Typical Characteristics (Continued)

Power Dissipation

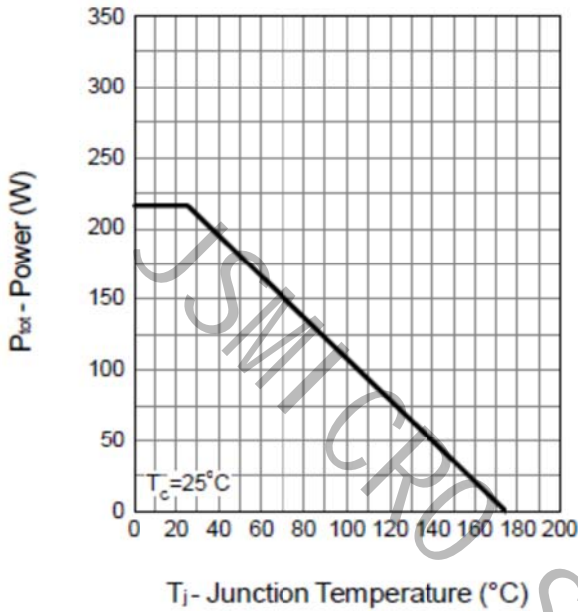

Drain Current

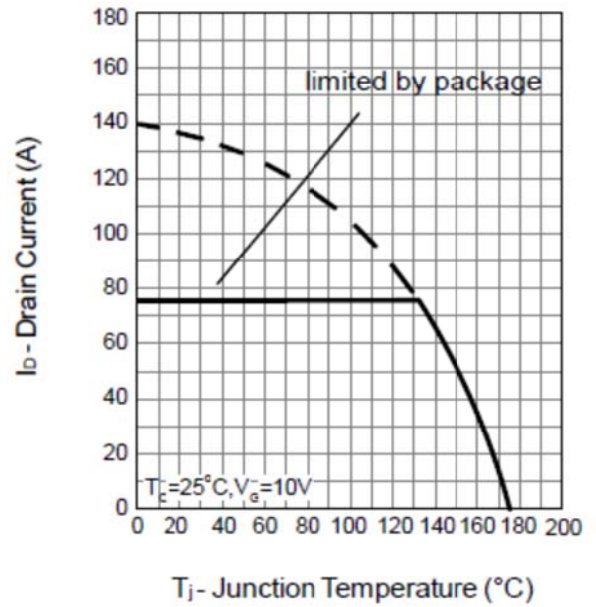

Safe Operation Area

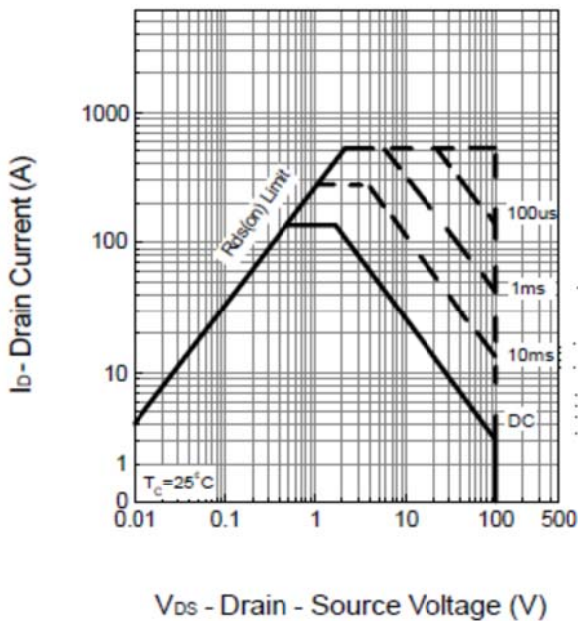

Thermal Transient Impedance

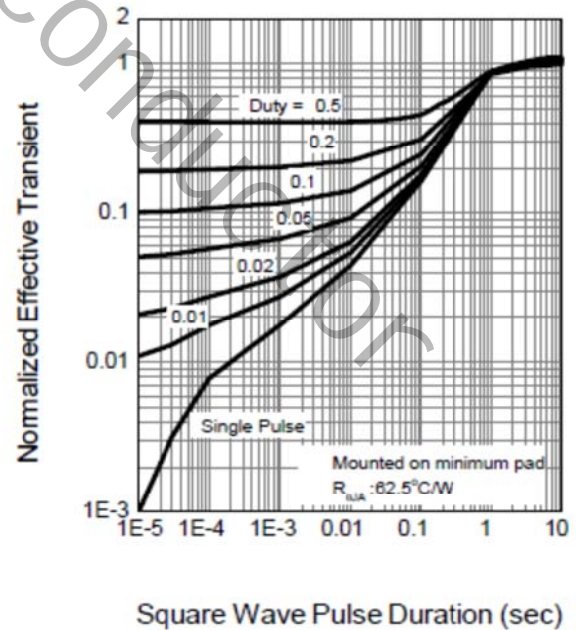

Package Dimension

TO-220

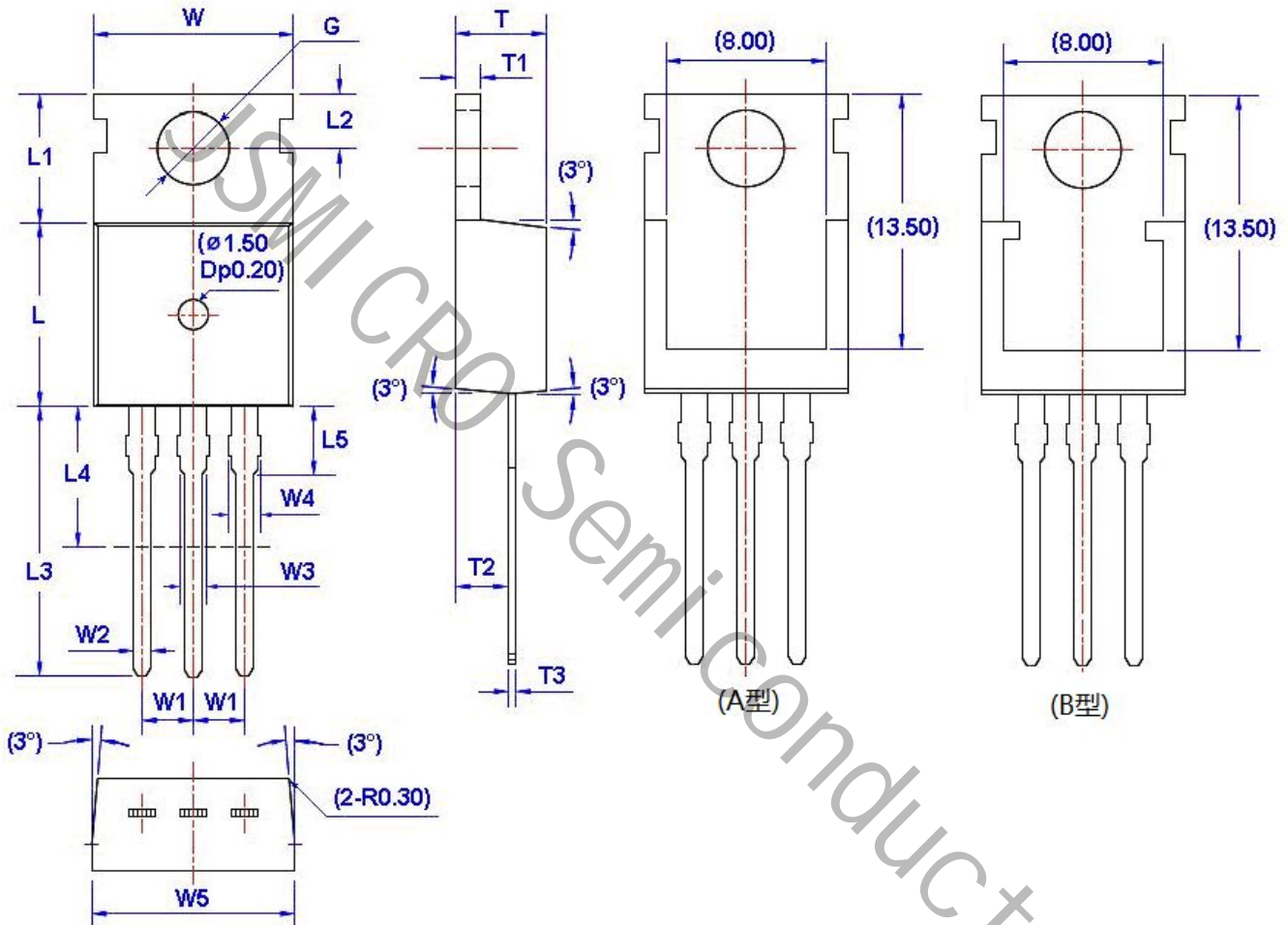

符号	尺寸		符号	尺寸		符号	尺寸		符号	尺寸	
	Min	Max		Min	Max		Min	Max		Min	Max
W	9.66	10.28	W5	9.80	10.20	L4**	6.20	6.60	T3	0.45	0.60
W1	2.54 (TYP)		L	9.00	9.40	L5	2.79	3.30	G(Φ)	3.50	3.70
W2	0.70	0.95	L1	6.40	6.80	T	4.30	4.70			
W3	1.17	1.37	L2	2.70	2.90	T1	1.15	1.40			
W4*	1.32	1.72	L3	12.70	14.27	T2	2.20	2.60			