

● **Features:**

- Common Cathode Structure
- Low Power Loss and High Efficiency
- Ultra Low Forward Voltage Drop
- High Surge Capability

● **Application:**

- High Frequency Switch
- Free Wheeling, and Polarity Protection Applications

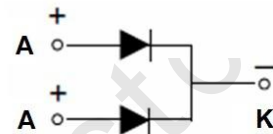
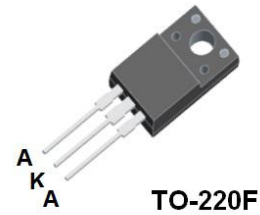

**Absolute Maximum Ratings**( $T_c=25^{\circ}\text{C}$  unless otherwise noted)

Symbol	Parameter	Value	Unit
$V_{RRM}$	Maximum Repetitive Reverse Voltage	100	V
$V_R$	Maximum DC Reverse Voltage	100	V
$I_{F(AV)}$	Average Rectified Forward Current, $T_c=120^{\circ}\text{C}$	10(Per Leg) 20(Per Device)	A
$I_{FSM}$	Peak Forward Surge Current, 8.3ms Half Sine wave	150	A
$T_j$	Operating Junction Temperature	150	$^{\circ}\text{C}$
$T_{stg}$	Storage Temperature Range	-55 to +150	$^{\circ}\text{C}$

**Thermal Characteristics**( $T_c=25^{\circ}\text{C}$  unless otherwise noted)

Symbol	Parameter	Max	Unit
$R_{\theta JC}$	Thermal Resistance, Junction to Case Per Leg	3.5	$^{\circ}\text{C}/\text{W}$

**Electrical Characteristics**( $T_c=25^{\circ}\text{C}$  unless otherwise noted)

Symbol	Parameter	Test Conditions	Min	Max	Unit
$V_{RRM}$	Maximum Repetitive Reverse Voltage	$I_R=100\mu\text{A}$	100		V
$I_R$	Reverse Current	$V_R=100\text{V}$ $T_c=25^{\circ}\text{C}$ $V_R=100\text{V}$ $T_c=125^{\circ}\text{C}$		0.1 15	mA
$V_F$	Forward Voltage	$I_F=10\text{A}$ $T_c=25^{\circ}\text{C}$ $I_F=10\text{A}$ $T_c=125^{\circ}\text{C}$ $I_F=20\text{A}$ $T_c=25^{\circ}\text{C}$ $I_F=20\text{A}$ $T_c=125^{\circ}\text{C}$		0.73 0.63 0.83 0.73	V

$V_F$  Typical Values: 0.66V@  $I_F=10\text{A}$ ,  $T_c=25^{\circ}\text{C}$

## Typical Performance Characteristics

**Figure 1. Forward Current Characteristics**

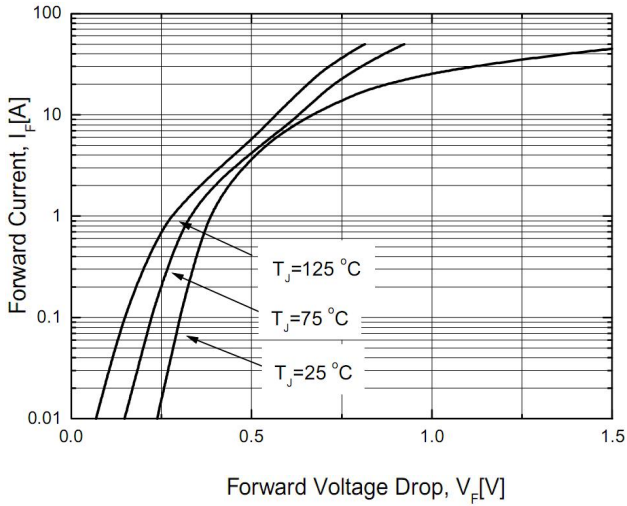

**Figure 2. Reverse Leakage Current**

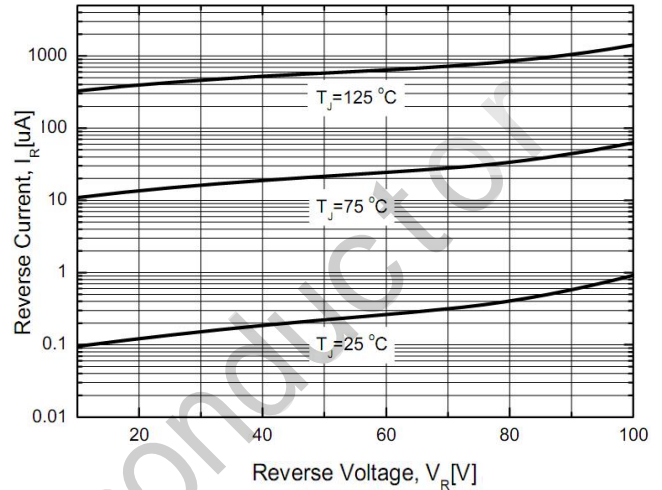

**Figure 3. Junction Capacitance**

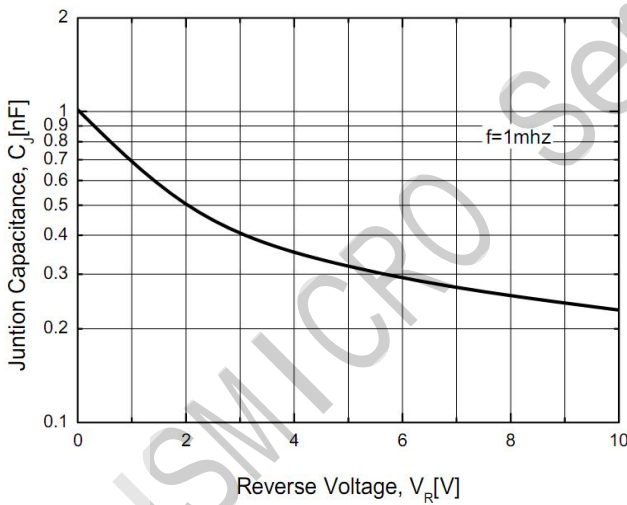

**Figure 4. Power Derating**

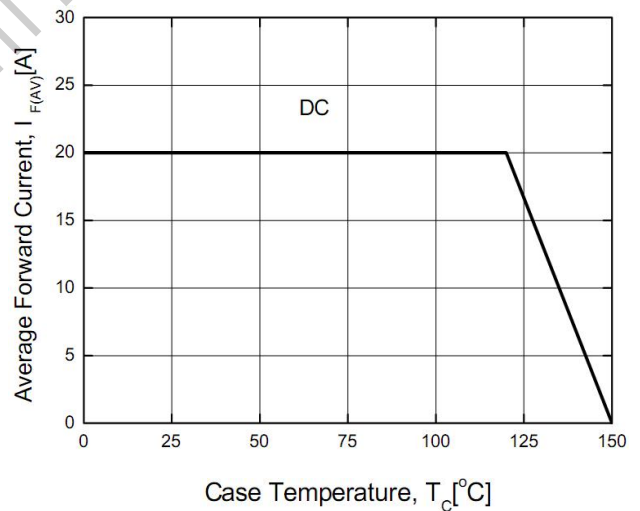

### TO-220F Package Dimensions

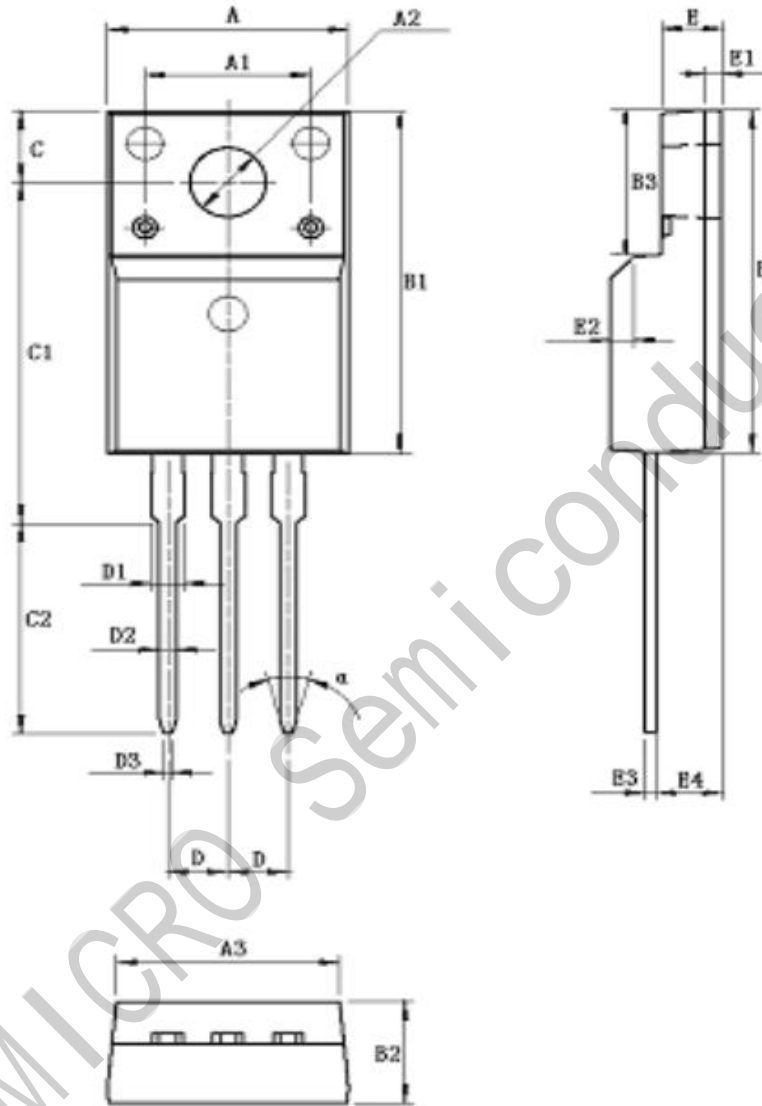

UNIT: mm

SYMBOL	min	nom	max	SYMBOL	min	nom	max
A	9.80		10.60	D		2.54	
A1		7.00		D1	1.15		1.55
A2	2.90		3.40	D2	0.60		1.00
A3	9.10		9.90	D3	0.20		0.50
B1	15.40		16.40	E	2.24		2.84
B2	4.35		4.95	E1		0.70	
B3	6.00		7.40	E2		1.0×45°	
C	3.00		3.70	E3	0.35		0.65
C1	15.00		17.00	E4	2.30		3.30
C2	8.80		10.80	α (度)		30°	